

Planetary gears

IMS.42 Eco

Our plastic planetary gear from the Eco Series with outer diameter 42 mm combines efficiency with economy.



Economy
Modular system, optimized material mix: For economic solutions even in small quantities



Temperature
Also ideally suited for demanding temperature ranges from -15° to +65°C.



Technical data	1-stage	2-stage	3-stage
Permissible output torque TAB (CB = 1.0)	0.8 Nm	2.0 Nm	4.0 Nm
Gear efficiency approx.	0.8	0.8	0.7
Max. Gear backlash	1.7 °DEG	1.8 °DEG	1.8 °DEG
Recommended input speed	3.000 rpm	3.000 rpm	3.000 rpm

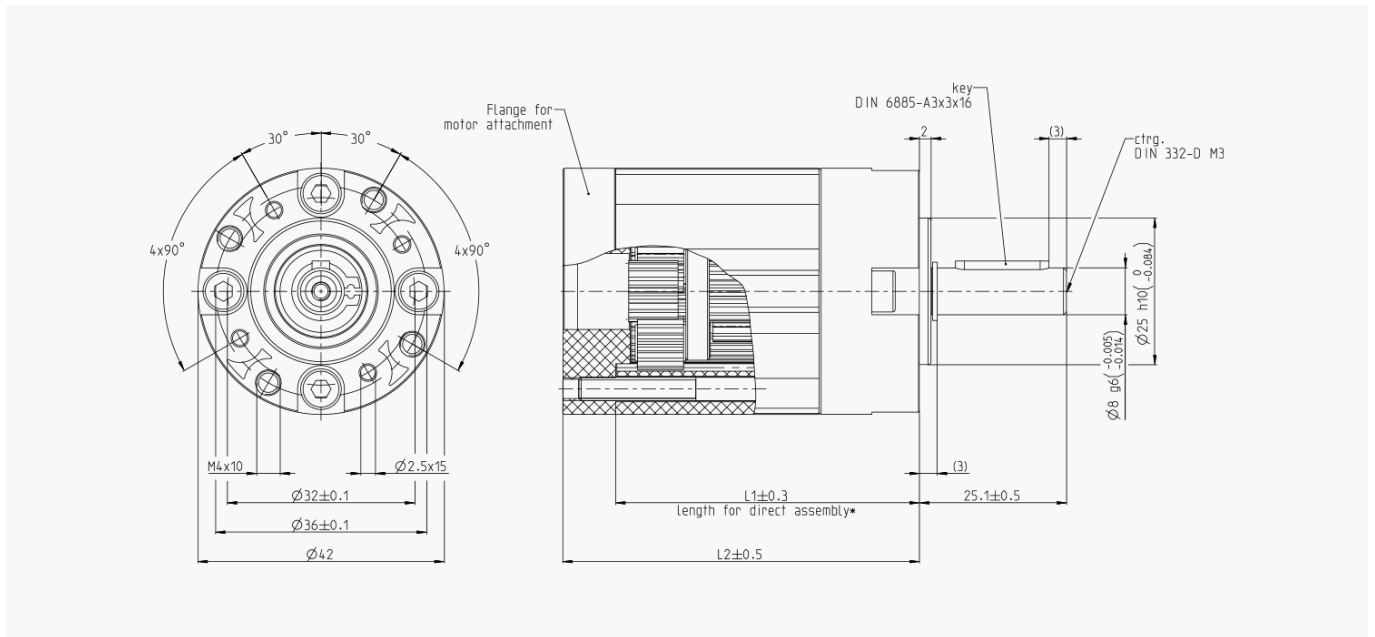

All dimensions in millimetres [mm]

Reductions

1-stage	2-stage	3-stage
4:1 (3,71)	14:1 (13,73)	51:1 (50,89)
4:1 (4,29)	16:1 (15,88)	59:1 (58,86)
5:1 (5,18)	18:1 (18,37)	68:1 (68,07)
7:1 (6,75)	19:1 (19,20)	71:1 (71,16)
	22:1 (22,21)	79:1 (78,72)
	25:1 (25,01)	93:1 (92,70)
	27:1 (26,85)	95:1 (95,18)
	29:1 (28,93)	100:1 (99,51)
	35:1 (34,98)	107:1 (107,21)
	46:1 (45,56)	115:1 (115,08)
		124:1 (123,98)
		130:1 (129,62)
		139:1 (139,14)
		150:1 (149,90)
		169:1 (168,85)
		181:1 (181,25)
		195:1 (195,27)
		236:1 (236,10)
		308:1 (307,55)

Output side with ball bearing	1-stage	2-stage	3-stage
Max. radial load (centre of output shaft)	15,0 N	30,0 N	45,0 N
Max. Axial load	5,0 N	10,0 N	30,0 N
Max. permissible contact pressure	150,0 N	150,0 N	150,0 N
Weight approx.	150 g	180 g	215 g

Gear length	1-stage	2-stage	3-stage
Length 1 ¹	38,9 ± 0,3	51,9 ± 0,3	64,8 ± 0,3
Length 2 ¹	48,7 ± 0,5	61,7 ± 0,5	74,7 ± 0,5

¹ A calculated minimum length of the gearbox is given under the condition of an optimal connection of flange and motor. Please contact us directly for your specific project.

All data in this brochure are approximates

Deviations are possible and are due, for example, to non-standardized testing and measuring methods. Please contact us directly for detailed information. We reserve the right to make technical changes without prior notice. Please refer to our website www.imsgea.com for the current status.